

FDR D-EVO™ Suite II Suite II with Auto-Stitching

ISS
Technology

Wireless

Dynamic
Visualization

GOS
Scintillator

CsI
Scintillator





High-performing, fully integrated DR room solutions for your everyday imaging needs.

FDR D-EVO Suite II is precisely what your busy radiology department needs to stay at the forefront of digital imaging. FDR D-EVO Suite II integrates Fujifilm's high-efficiency detectors and imaging software to deliver outstanding image quality with low patient dose, easy workflow, and exceptional reliability. Flexible configurations allow you to select just the right solution to match your clinical preferences and operational budget.

FDR D-EVO Suite II brings exciting dose efficiency advancements such as our exclusive Irradiated Side Sampling (ISS) detector technology and Dynamic Visualization processing. Features include user workflow enhancements such as touchscreen tube head display, automated tube tracking to table and upright, SpeedLink exposure optimization, increased weight capacity, and a very low table-to-floor height capability.

This complete DR room replacement system is designed to provide all of the benefits you expect from Fujifilm, including fast image preview and cycle times, workflow-enhancement features, and lightweight removable detectors that are easy to position and comfortable for the patient.

Automated long-length imaging – The FDR D-EVO Suite II with Auto-Stitching system configuration includes special image processing, motorized chest stand, additional tube automation, and a patient positioning guidance shield. Imaging is fast and easy. Automated, synchronized detector movements and tube angulations acquire up to 3 images, which combine into one seamless long-length image up to 48" long. FDR D-EVO Suite II performs fast, consistent, and precise scoliosis and long-leg exams in seconds.



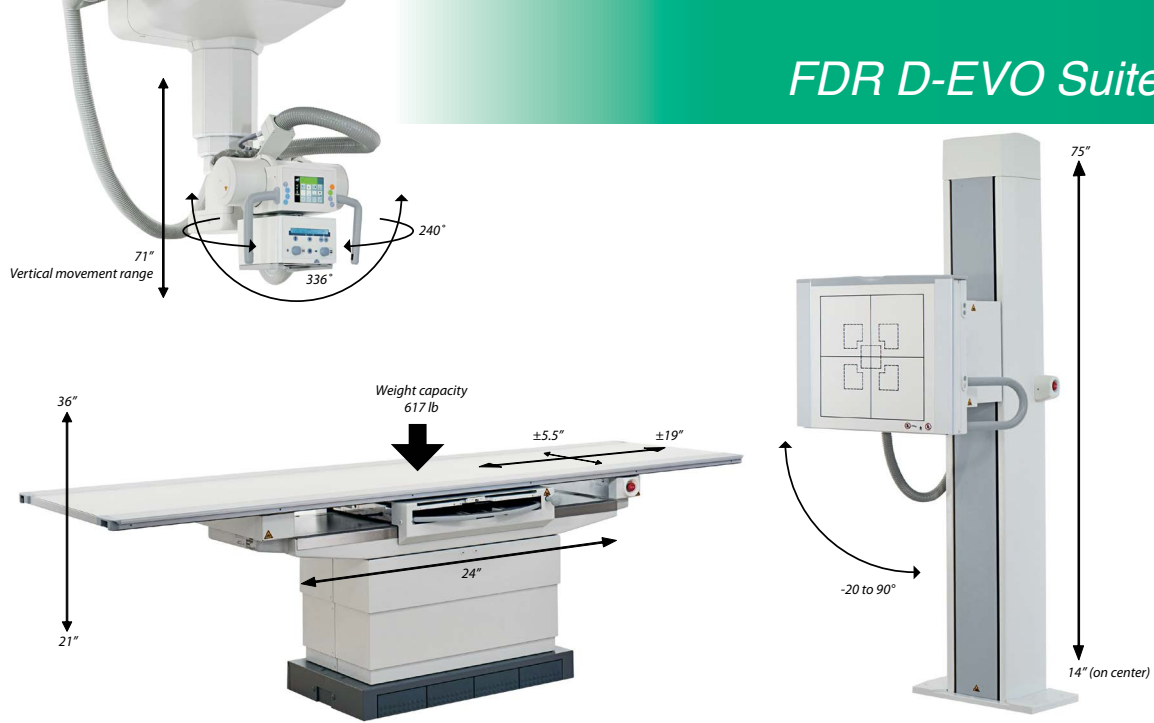

Ceiling-suspended Tube System

Productivity. Touchscreen display located at the tube head conveniently allows exam adjustments without leaving the patient side.

Perfect fit. The improved tube system design allows a short tube-to-ceiling distance that accommodates more room sizes with even lower or higher ceilings than before.

Just the right mix of motorized and manual operation. The light, easy movement and simplified positioning of the tube's grip handles and function buttons make it perfect for routine and urgent grab-and-go performance. A fully manual nontilting system is also available for restricted space and budgets.

Fast, easy workflow. Great for fast, precise positioning critical for orthopedic, trauma, and emergency department applications. Tube tracking automatically synchronizes tube position with the table and chest stand height adjustments.



Chest Stand

Both tilting and nontilting chest stands are available, each featuring light, easy, one-hand bucky detector tray operation. Bucky trays will accommodate standard 14x17" or 17x17" detectors. The standard tilting model is required for automatic tube tracking functions. Both include a user-removable grid and overhead patient support handle.

A third option is the chest stand for automated long-length imaging. The system acquires up to 3 images at the chest stand only, which combine into one seamless long-length image up to 48" in length. It features a tilting chest stand and user-removable grid and is designed for use with 17x17" GOS or Csl Fujifilm detectors (once installed, the chest stand detector is not user-removable). The system includes a patient positioning shield that is light and easy to use, with locking wheels, patient handles, and an open base to allow for use with a step for long-leg exams.

Table

The 4-way float top table is motorized, height-adjustable, and ergonomically designed to eliminate all sharp edges. It can be lowered to as low as just 21" from the floor for easy patient accessibility and supports up to 617 lb. Patient grip handles can be easily repositioned or removed, and table adjustments are controlled with table base toe switches. Toe switches are vertically positioned, safe from the patient accidentally stepping on them. For even easier technologist reach, additional rear side switches can also be included as an option. Anti-collision patient protection sensors designed to detect upward resistance applied to the table as it is lowered are standard features with FDR D-EVO Suite II.

Generator

Available in a 55 or 80kW 3-phase power system, the generator features falling load technology that enables exposure to start immediately at the full power level set by the requested technique to achieve the shortest possible exposure times. Settings can be adjusted at the generator control console, at the tube display, and preset by the FDX Console workstation via the SpeedLink interface, which automates preferred exposure techniques, filters, collimation format, and device to the exam menu selected.

Components and Customizations

FDX Console:	Technologist workstation for exam processing, image preview, QC, and transmission. Featuring Dynamic Visualization, QC and Dose Management, SpeedLink connectivity, and more. Optional secondary high-resolution monitor available for PACS-comparable preview and advanced QC features.
Detectors:	Designed for DR integration with FDR D-EVO II and FDR ES detectors (sold separately). Auto Cassette Size Sensing (ACSS) requires motorized OTC.
Generator:	Available in a 55 or 80kW 3-phase system, tabletop console included.
Tube System:	Motorized overhead tube crane with touchscreen tube display, automated tube-to-detector tracking, and automatic collimator. Manual tube system without automatic collimation is also optionally available for FDR D-EVO Suite II.
Table:	4-way floating tabletop, patient weight capacity 617 lb. Motorized elevation to as high as 36" or as low as only 21" from floor.
Upright:	Nontilting or tilting bucky (+90° to -20°) available with left- or right-loading removable detectors. Auto long-length model features tilting bucky, and once installed, its 17x17" detector is not user-removable.
Grids:	User-removable grids included standard (all models).
Long-length Stitching:	Automated long-leg and scoliosis exams up to a length of 48" are possible at the upright with the FDR D-EVO Suite II with Auto-Stitching system configuration. System includes automated long-length imaging software, motorized upright, additional tube motorization, and patient positioning shield. This functionality is not field-upgradeable.

Note: Standard motorized overhead tube system and tilting upright chest stand are required for auto collimation and tracking functionality.



FDR D-EVO II and FDR ES Detectors

FDR D-EVO Suite II is designed for use with Fujifilm's latest DR detectors, providing the flexibility, efficiency, and image quality your staff and patients deserve. The detectors feature patented ISS capture technology and are available in 14x17", 17x17", 24x30cm sizes with GOS or CsI capture. Our lightweight, durable detectors provide image preview in as little as 2 seconds and about 9 seconds cycle time.

ISS Capture Technology

This unique technology positions its capture electronics (TFTs) at the irradiation side, in contrast to traditional detectors. This design significantly suppresses scattering and attenuation of X-ray signals, improving efficiency to produce sharper images at lower doses compared to traditional designs.*

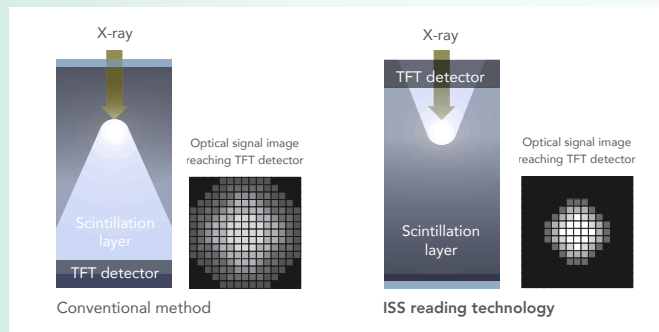

FDX Console

The FDX Console brings your entire room and department together with seamless integration and simple and fast workflow. Its customizable intuitive interface allows exam completion in as few as 3 easy steps and connectivity with multiple FDR and FCR devices, even within the same exam. The FDX Console features Dynamic Visualization, Fujifilm's sophisticated image processing that intelligently clarifies images for higher visibility detail and enables a wider range of window and leveling throughout the entire image. Other time-saving features include worklist status icons and thumbnails, simplified QA tabs, Auto Trimming for off-center positioned exams, easy detector status, and sharing tools. The FDX Console interfaces its SpeedLink X-Ray Control Software™ to automate preferred dose techniques, mapped from each exam menu to the generator console. It also offers dose management with unlimited customizable menus for variables such as patient size or age, along with dose data tracking capabilities, including support for IEC (Exposure and Deviation Index), Dose Structured Reporting, Dose Area Product and more.



* Based on higher MTF and DQE demonstrated in "Effect of X-ray incident direction and scintillator layer design on image quality of indirect conversion flat-panel detector with GOS phosphor" by K. Sato, et al.

FDR D-EVO Suite II Specifications

Chest Stand Specifications	Upright Nontilting	Upright Tilting	Upright Tilting (with Auto-Stitching)
Dimensions	37.4" l x 30" w x 82.9" h Vertical travel range: 15.0" to 70.9" above floor	48.9" l x 30" w x 82.9" h Vertical travel range: 13.4" to 68.1"	48.9" l x 30" w x 82.9" h Vertical travel range: 10.4" to 68.8"
Weight	429 lb	517 lb	529 lb
Detector (sold separately)	Removable	Removable	Nonremovable

Generator Specifications	GEN RF 80 (80kW)	GEN RF 55 (55kW)
High-voltage waveform multi-pulse power rating (55 kW acc. IEC 60601)	* 1000 mA at 60 kV 800 mA at 100 kV 667 mA at 120 kV 533 mA at 150 kV *	* 640 mA at 60 kV 550 mA at 100 kV 458 mA at 120 kV 367 mA at 150 kV *
Exposure voltage 40 kV to 150 kV		
Power line connection 3-phase	480 V ±10%, 50/60 Hz	480 V ±10%, 50/60 Hz
Line impedance 400v 440v 480v	0.11 ohm (400 V) 0.14 ohm (440 V) 0.16 ohm (480 V)	0.17 ohm (400 V) 0.20 ohm (440 V) 0.24 ohm (480 V)
Ambient conditions during operation Temperature range: 10 to 40°C Rel. humidity: 20 to 75%, above dew point Barometric pressure: 70 to 106 kPa Weight Weight: High-voltage transformer 422 lb Control Console: approx. 3.3 lb	* * * * *	* * * * *

All systems include:

Automatic control
1-point technique with continuously falling load and AEC
2-point technique with constant load

mAs integrator
From 0.5 to 800 mAs

Exposure time
1-point technique: 1 ms to 5 s with mAs-post-indication
2-point technique: 2 ms to 5 s depending on mAs and kV

Tube assembly (IT)
Adaptable to one X-ray tube assembly with two foci (max)
Automatic exposure control IONTOMAT, two input channels

Tolerances
kV accuracy ±5%
mAs accuracy ±5% or 0.5 mAs, whichever is greater

Overhead Tube Crane System

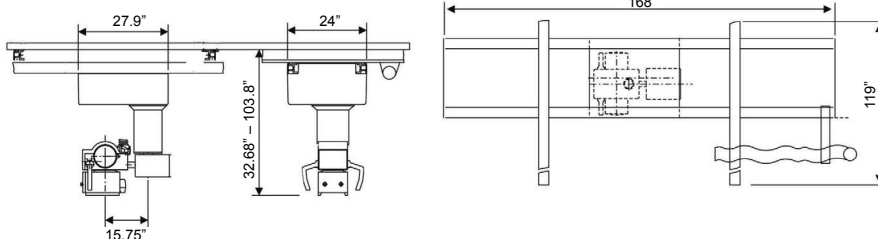

Table (front)

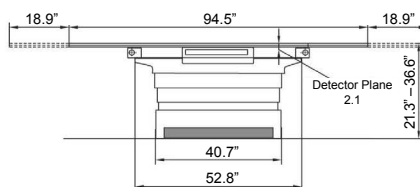
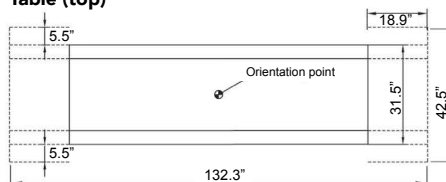
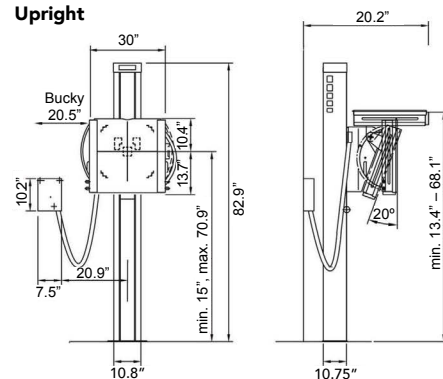

Table (top)



Upright



Long-length Imaging Patient Stand

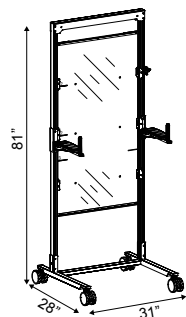

Also includes:

Generator cabinet: 40.2" x 21.6" x 21"
Generator console: 3" x 10" x 11"